

Tweak CLD LED.

The free-standing luminaire of today, for tomorrow.

Efficient
and
ergonomic.





It all starts with our knowledge.

What you should know, too.

5

Tweak CLD LED.

Far more than a free-standing luminaire.

8

ALONE at WORK®

The intelligent communication technology,
built-in to your free-standing luminaire.

18

Product range.

23

We follow strict rules.

The Regent test lab.

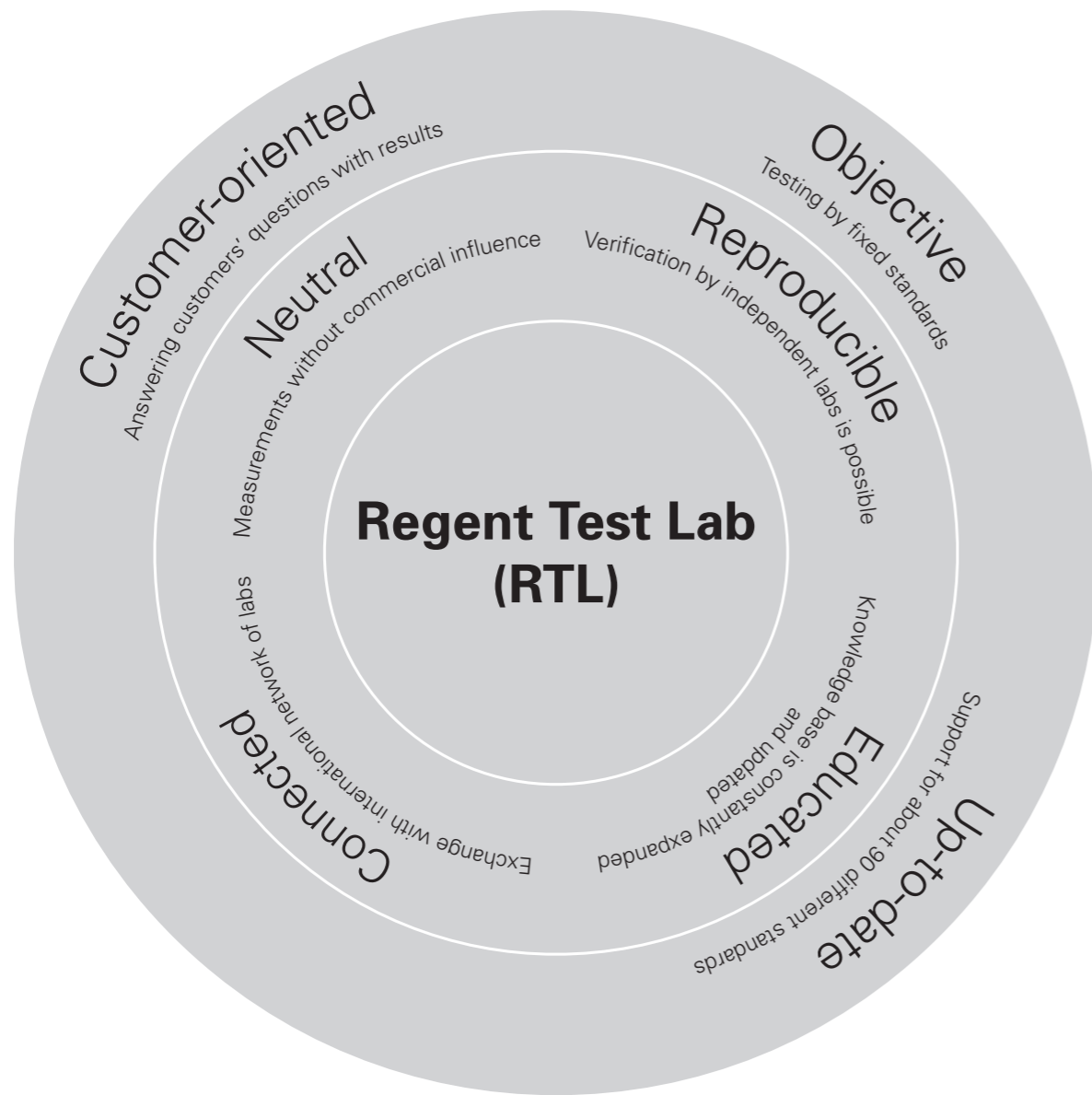

It all starts with our knowledge.

What you should know, too.

Knowledge is the basis for truly being able to implement LED technology to its maximum potential. Only once you have mastered the fundamentals you can start to ask the right questions. That's why our in-house light lab has a broad analysis spectrum and experienced light experts. Lively exchange with external institutions, universities, and industry specialists guarantees that our knowledge and technology remain on the cutting edge. We expand our know-how every day and conduct regular advanced training sessions and quality management assessments to ensure that our technical expertise in the lab is always at the highest level.

Our research and development activities are designed to meet industry demands and customer preferences, always connecting practice-based research with the concrete needs of the market.

As such, Regent is able to offer products, services, and solutions on the market that support our partners' innovative strengths while optimising light quality. This need-oriented, in-depth research was crucial to developing innovations like Slyder®, bus interface, and ALONEatWORK®, all of which can be found in the Tweak CLD LED.



The challenge.

The office world in flux.

Be it individual workstation design, efficiency criteria, or ergonomics – office organisation has to adapt constantly to new demands. This means solutions that are highly flexible, ergonomic, and economical are required. Thanks to a broad-minded concept and innovative technologies, the free-standing luminaire, Tweak CLD LED, provides answers to the questions of the office of tomorrow.



The solution.

The free-standing luminaire that does not stand still in time.

Think new. The Tweak CLD LED represents a new generation of free-standing luminaires designed by Regent in cooperation with architects schneider+schumacher. With its intuitive operating concept and user-friendly electronic interface, the Tweak CLD LED is flexible enough to meet all your needs. With its modern design, single-cast luminaire head, and smooth elegance, the Tweak CLD LED fits in anywhere. A mobile luminaire that can be integrated into any environment without intruding.



Till Schneider



Tim Ahlswede

- Glare elimination value UGR < 16: very well suited for situations with high visual demands (according to EN/SN 12464-1)

- Indirect light and direct light can be dimmed individually (depending on construction) light distribution: -30% direct light, 70% indirect light (92W Version); -25% direct light, 75% indirect light (110W Version)
- Closed cover allows easy cleaning

- High light quality due to microprismatic CLD optics (Controlled Luminance Diffusor), available with LED or for compact fluorescent lamps
- Optimal glare elimination
- Homogenous, even illumination
- Broad, indirect emission patterns
- High efficiency: Tweak CLD LED up to 100lm/W

- Housing made of one-piece die cast aluminium

- Steel rod

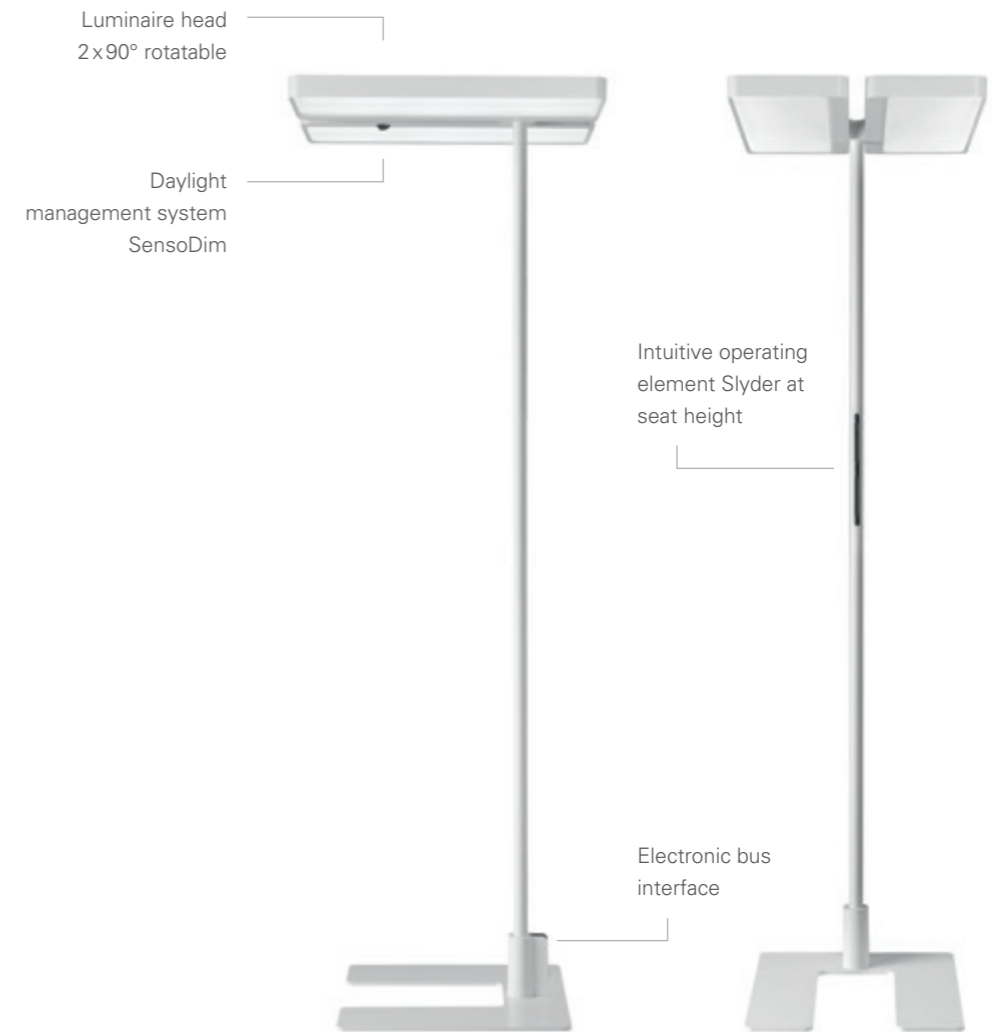

Tweak CLD LED. Far more than a free-standing luminaire.

The first things that strike you about the Tweak CLD LED free-standing luminaire are its impressive form, design, and construction. But then you notice its true strengths: the intuitive operating element Slider®, SensoDim®, multifunctional interface, communication technology ALONEatWORK®, and the most modern LED technology that all work together to answer the demands of the office world of tomorrow. Tweak CLD LED fits into any environment, gives light a form, and serves as an intuitively applicable tool that enriches and facilitates daily office work.



Discover light in motion.
www.vimeo.com/62146242



Certified by the Swiss Agency for Energy Efficiency for high efficiency and good technical characteristics

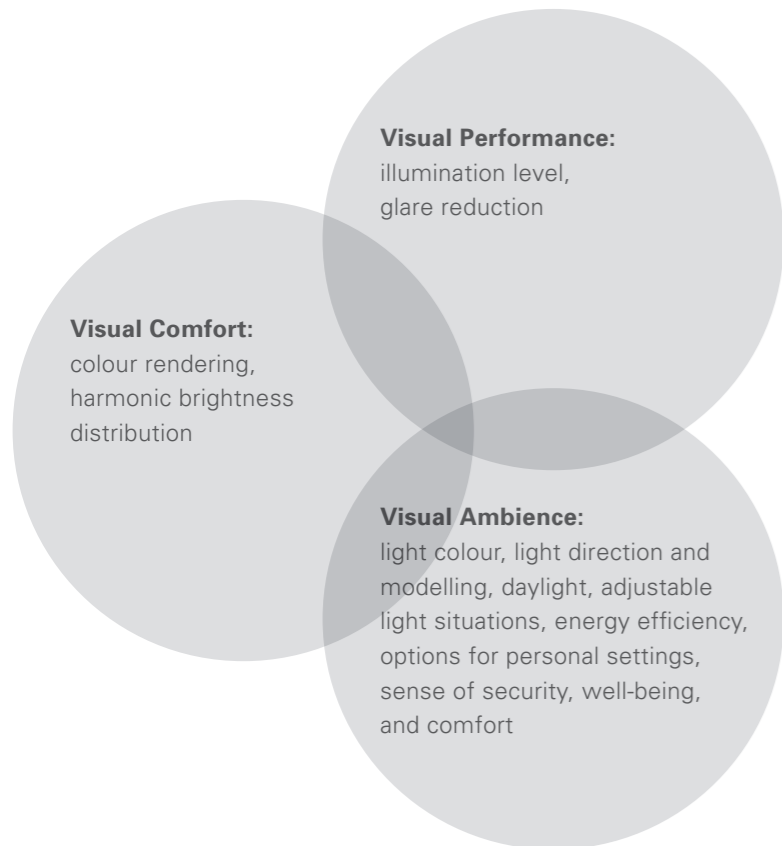
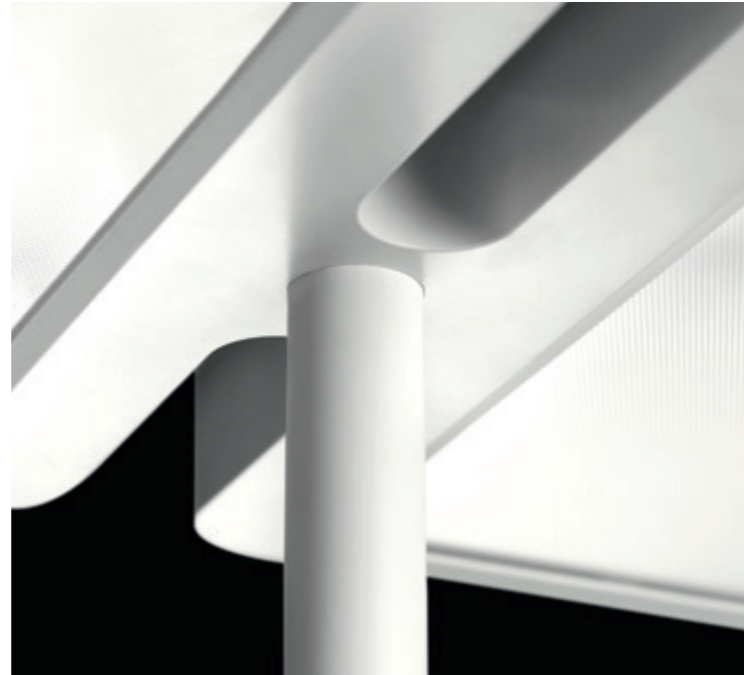

Efficient illumination means efficient total solutions in terms of the light's quality, characteristics, and adjustable features. Only then can artificial illumination solutions provide a light atmosphere that is truly efficient and inviting.

Light for a better workstation.

To ensure individual interior ambience, one must optimise the interaction between people and light. That is why the Tweak CLD LED emphasises perfect balance between luminosity, evenness, glare reduction and colour rendering. Various lighting design options, such as illuminant, colour, mounting and the communication technology, presence control module and operating elements individualise the light and guarantee a highly refined and individual sense of well-being at each workstation.

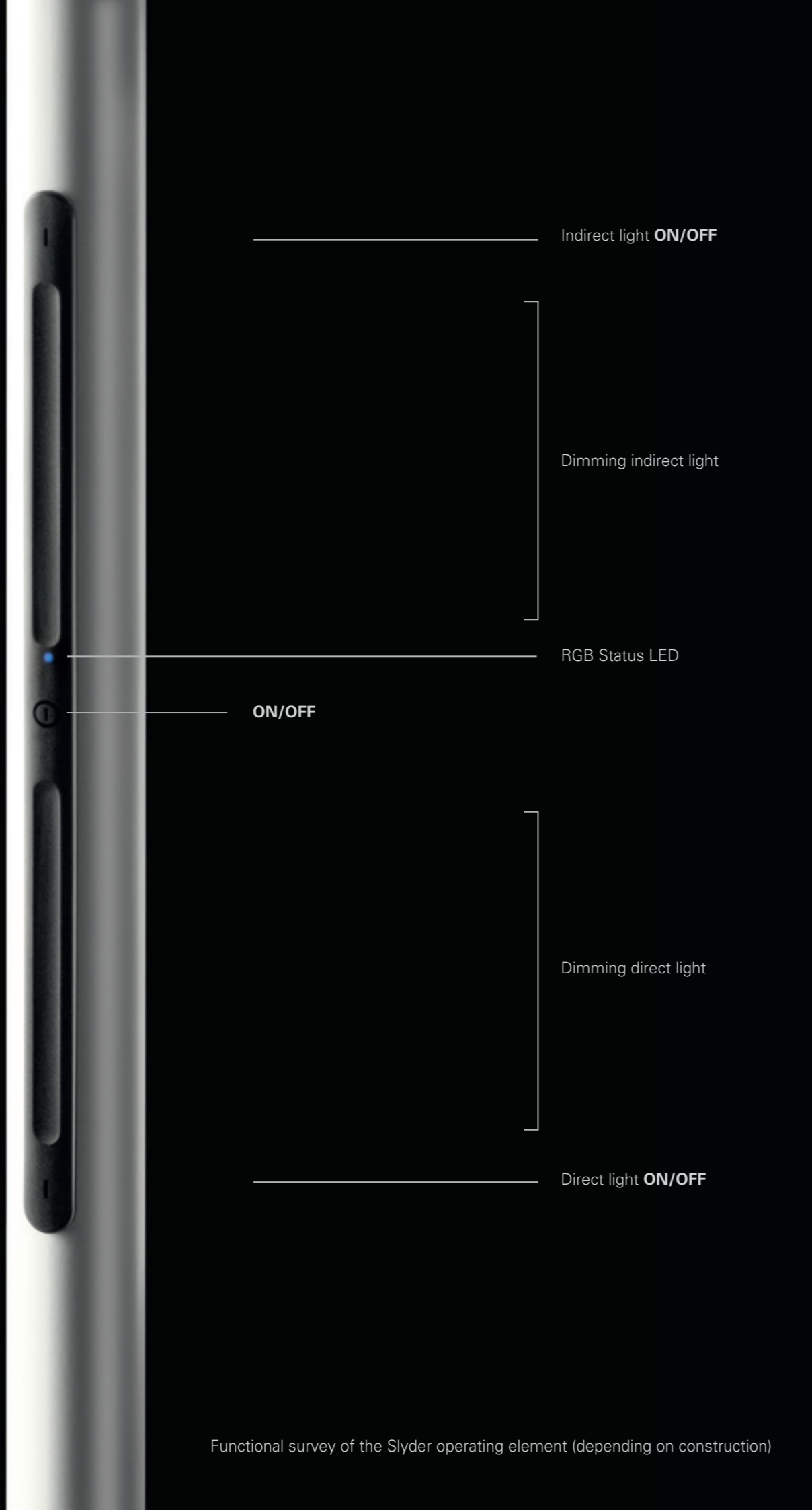

Functional survey of the Slider operating element (depending on construction)



Intuitive dimming on the standpipe: indirect light

Intuitive dimming on the standpipe: direct light

Intuitive operating element Slider®

Light by degrees.

The Tweak CLD LED is based on a completely new lighting concept with various possibilities that exceed the capabilities of normal lighting controls. It is no wonder that a new type of operating element had to be created. With the innovative Slider®, Regent developed an intuitive operating element to meet these new challenges. Now it is possible for the user to adjust the free-standing luminaire to meet his or her individual needs, to explore the full range of the luminaire's capabilities and to control both direct and indirect light flexibly.

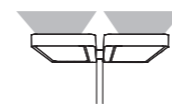

Indirect light ON/OFF

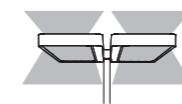

Luminaire ON/OFF

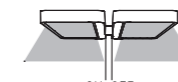

Direct light ON/OFF

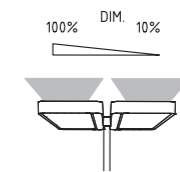

Dimming indirect light

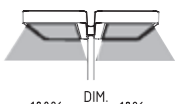

Dimming direct light

Functional survey of the Slider operating element (depending on construction)

The luminaire head.

The lamp that adjusts to you.

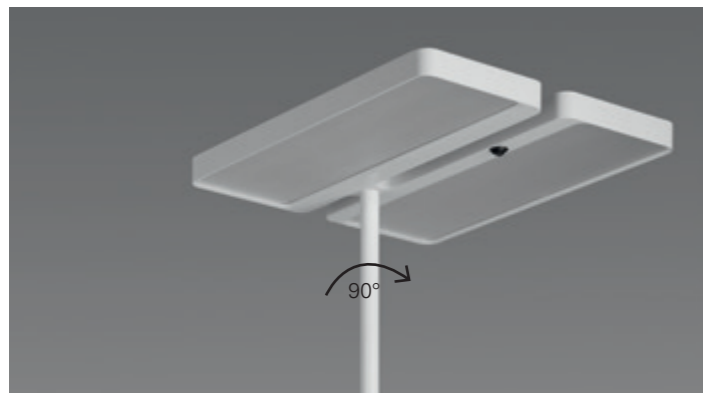
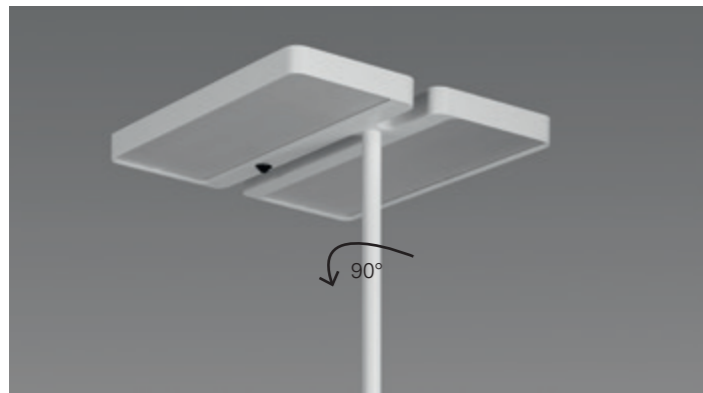

A free-standing luminaire – Three positions.

The Tweak CLD LED adjusts to any situation. The single-cast luminaire head rotates into any position via 2x90° without sacrificing light quality.

SensoDim® – designed for your situation.

The Tweak CLD LED can add the option of sophisticated SensoDim technology. Presence- and daylight-dependent lighting control automatically gauges ambient illumination and recognises the workstation occupancy. In addition, users can set their own illumination levels, control luminous flux individually and change light level at the touch of a button. The sensor can also be configured manually to ensure both optimum workstation atmosphere and maximum efficiency.



The luminaire base.

This bottom is top-of-the-line.



A base you can be proud of.

We left nothing to chance when designing this luminaire base. No matter how the luminaire head is positioned, the base ensures stability. The precise cut allows the luminaire to be positioned at two office tables with the maximum possible flexibility. At the opposing end to the luminaire head, the base perfectly rounds out the overall image of the Tweak CLD LED.

Small access, big possibilities.

The fact that the Tweak CLD LED is a luminaire of the next technological generation is evident in its bus interface. This interface serves to break down the lighting configuration into various parameters and to connect it to existing building infrastructure while preserving all available features.



ALONE at WORK®

The intelligent communication technology integrated in your free-standing luminaire.

Its function is as simple as its appearance:

No switch, adjustment wheels, or screws – just put it in place.

Optimum design for use with mobile luminaires –

ALONE at WORK® takes care of everything for you.

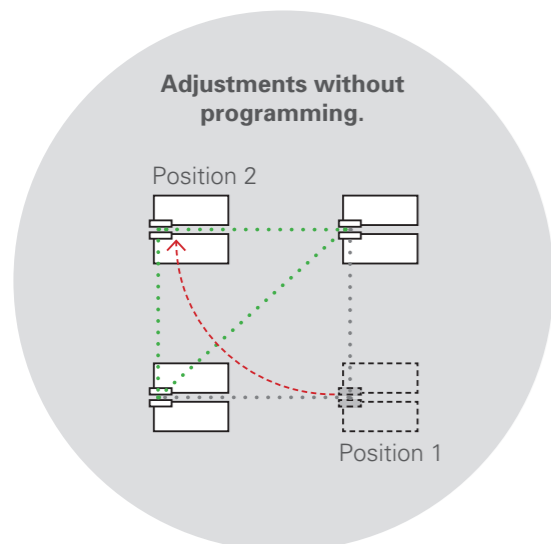

- Maximum room ambience with minimum energy consumption
- Continuously fading light cloud for ergonomic office illumination
- Wireless communication between mobile luminaires
- Networking with non-hazardous opto-electronic communication
- Positioning, position adjustment, and exchange without programming knowledge
- Autonomous intelligence without installation



The communication module ALONE at WORK can be mounted on the luminaire head without tools.

A special mounting plate guarantees optimum positioning.

ALONE at WORK®
INTELLIGENT COMMUNICATION TECHNOLOGY

Simulation: Open space with light islands



Simulation: Light cloud by ALONEatWORK



Self-configured and wireless networking: adjustment without programming



The challenge.

In dark spaces, light is not the only thing that disappears. So does performance.

When darkness falls, occupied workstations in a large office space transform into disconnected light islands. The transition from bright to dark is abrupt and gives the feeling of being isolated. Concentration lapses, irritation, and inefficiency result. The efficiency-enhancing communication technology ALONEatWORK® is the answer.

The solution.

Intelligent illumination, concentrated work. With ALONEatWORK®.

ALONEatWORK® connects all luminaires in an open space via non-hazardous opto-electronic communication. The self-regulating ALONEatWORK technology transforms the hard lines of light islands into ergonomic light clouds around each occupied workstation – all by itself, with optimum energy consumption, and without any effort on your part.

Adjustment without programming.

ALONEatWORK is prepared to handle individual workstation design and spatial adjustments to changes. The luminaires adapt to new situations without any programming.



Vodafone Germany, with its headquarters in Düsseldorf, is one of the largest telecommunications providers on the German market. With its new group headquarters, the completely integrated communication firm made space for 5,000 employees on an 86,000 square metre campus. The campus stands for communication, creativity, and a lot of free space for the employees. In-depth knowledge about modern office space design was a major influence on Vodafone campus design – the needs of the employees, however, were of central importance.

The Vodafone campus.

Vodafone communicates with ALONE atWORK®.



Interview with Hendrik Grempe,
Head of Property Management at
Vodafone, Düsseldorf.

Why was communication technology so important to you when planning the lighting design?

With free-standing luminaires, solutions that apply only to individual workstations lead to strong contrasts in brightness in the space. This hard bright-dark contrast is very dissatisfying and fatiguing from an ergonomic perspective. We wanted to avoid this problem in the least complicated way possible.

What were the needs that made you opt for the ALONE atWORK® technology? Personnel needs (e.g. flexible work shifts) or spatial concerns (e.g. open space office design)?

We wanted a highly flexible open space lighting concept using only mobile free-standing luminaires. Moreover, we wanted to comply with all standards for occupational health and safety. We worked with Regent to develop a customised ALONE atWORK solution for the Vodafone campus project.

Which were the special challenges in terms of communication technology for this project?

With Vodafone there are, with just a few exceptions, almost no fixed assignments for workstations. We work 24/7 with large fluctuations in the workstation occupancy. So we needed a lighting concept that adapted as simply as possible to both personnel presence and daylight.

Why did you opt for ALONE atWORK in the end?

ALONE atWORK makes it easy to change and reorganise the luminaires in the room without costly and tedious programming.

How did ALONE atWORK differ from the competitors' offers?

The luminaires communicate via an opto-electronic connection rather than radio waves, so it's a completely non-hazardous solution.

Tweak CLD LED. Product range.



The product range comprises free-standing luminaires and wall-mounted luminaires with the CLD LED or CLD design. Free-standing luminaires are available in two heights (1950 mm and 2050 mm) with either single- or double-heads, and can also include Slyder® technology.

Single-cast luminaire housing made of aluminium die cast, high light quality with microprismatic CLD optics (Controlled Luminance Diffuser), very high efficiency of up to 100lm/W, Direct/indirect light separately dimmable, rotatable luminaire head by 2x90°, in white RAL 9016 matte or in silver VAG-EG1, interface on luminaire base for configuring lighting parameters, equipped for connection to building management via bus interface, configurable on a project-specific by modular controlling electronics, available with LED or for compact fluorescent lights

The luminaires are dimmable or equipped with the daylight- and presence-dependent light management system SensoDim®. The communication module ALONE atWORK® for wireless connection is available for single- and double-head luminaires.



Free-standing luminaires Tweak CLD LED, H 1950 mm.

With Slider® technology.

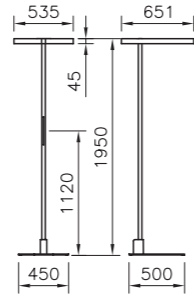

With Slider®	white		silver	
	4000K	3000K	4000K	3000K
110W dimmable	99W1102L1JR	99W1102L1DR	99H1102L1JR	99H1102L1DR
110W SensoDim®	99W1122L1JS	99W1122L1DS	99H1122L1JS	99H1122L1DS
92W dimmable	99W1102L3JR	99W1102L3DR	99H1102L3JR	99H1102L3DR
92W SensoDim®	99W1122L3JS	99W1122L3DS	99H1122L3JS	99H1122L3DS

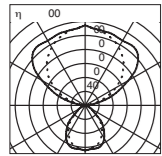

Psys 110W
LL 4000K 10'600lm
LL 3000K 9650lm
CRI > 80
L70 50'000h
UGR < 16

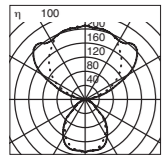

Psys 92W
LL 4000K 9200lm
LL 3000K 8400lm
CRI > 80
L70 50'000h
UGR < 16

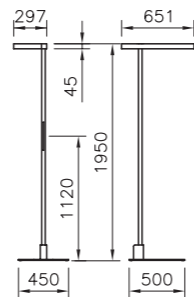

With Slider®	white		silver	
	4000K	3000K	4000K	3000K
46W dimmable	99W1202L4JR	99W1202L4DR	99H1202L4JR	99H1202L4DR
46W SensoDim®	99W1212L4JS	99W1212L4DS	99H1212L4JS	99H1212L4DS

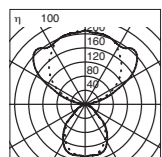

Psys 46W
LL 4000K 4600lm
LL 3000K 4200lm
CRI > 80
L70 50'000h
UGR < 16

Without Slider® technology.

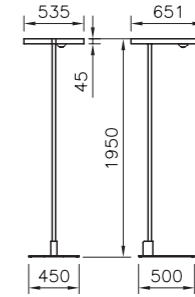

Without Slider®	white		silver	
	4000K	3000K	4000K	3000K
110W SensoDim®	99W1124L1JS	99W1124L1DS	99H1124L1JS	99H1124L1DS
92W SensoDim®	99W1124L3JS	99W1124L3DS	99H1124L3JS	99H1124L3DS

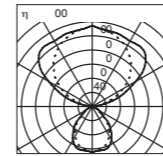

Psys 110W
LL 4000K 10'600lm
LL 3000K 9650lm
CRI > 80
L70 50'000h
UGR < 16

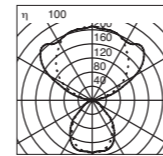

Psys 92W
LL 4000K 9200lm
LL 3000K 8400lm
CRI > 80
L70 50'000h
UGR < 16

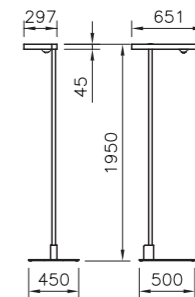

Without Slider®	white		silver	
	4000K	3000K	4000K	3000K
46W SensoDim®	99W1214L4JS	99W1214L4DS	99H1214L4JS	99H1214L4DS

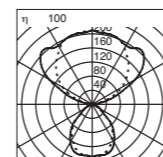

Psys 46W
LL 4000K 4'600lm
LL 3000K 4'200lm
CRI > 80
L70 50'000h
UGR < 16

Free-standing luminaires Tweak CLD LED, H 1950 mm.

With Slyder® technology.

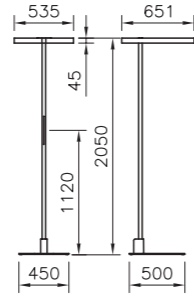

With Slyder®	white		silver	
	4000 K	3000 K	4000 K	3000 K
110W dimmable	99W1106L1JR	99W1106L1DR	99H1106L1JR	99H1106L1DR
110W SensoDim®	99W1126L1JS	99W1126L1DS	99H1126L1JS	99H1126L1DS
92W dimmable	99W1106L3JR	99W1106L3DR	99H1106L3JR	99H1106L3DR
92W SensoDim®	99W1126L3JS	99W1126L3DS	99H1126L3JS	99H1126L3DS

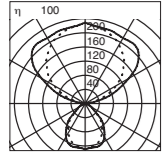

Psys 110W
LL 4000 K 10'600lm
LL 3000 K 9650lm
CRI > 80
L70 50'000h
UGR < 16

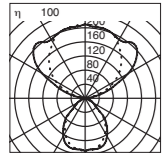

Psys 92W
LL 4000 K 9200lm
LL 3000 K 8400lm
CRI > 80
L70 50'000h
UGR < 16

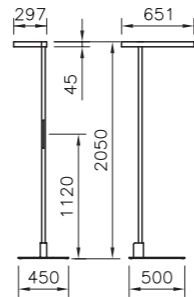

With Slyder®	white		silver	
	4000 K	3000 K	4000 K	3000 K
46W dimmable	99W1206L4JR	99W1206L4DR	99H1206L4JR	99H1206L4DR
46W SensoDim®	99W1216L4JS	99W1216L4DS	99H1216L4JS	99H1216L4DS

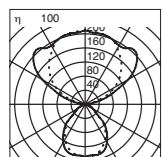

Psys 46W
LL 4000 K 4600lm
LL 3000 K 4200lm
CRI > 80
L70 50'000h
UGR < 16

Without Slyder® technology.

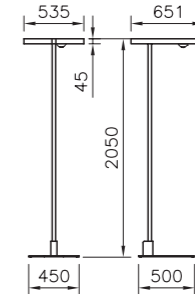

Without Slyder®	white		silver	
	4000 K	3000 K	4000 K	3000 K
110W SensoDim®	99W1128L1JS	99W1128L1DS	99H1128L1JS	99H1128L1DS
92W SensoDim®	99W1128L3JS	99W1128L3DS	99H1128L3JS	99H1128L3DS

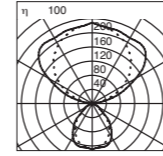

Psys 110W
LL 4000 K 10'600lm
LL 3000 K 9650lm
CRI > 80
L70 50'000h
UGR < 16

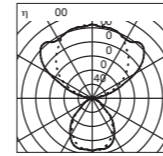

Psys 92W
LL 4000 K 9200lm
LL 3000 K 8400lm
CRI > 80
L70 50'000h
UGR < 16

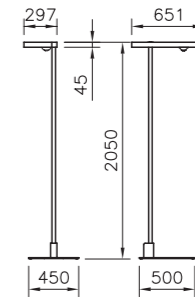

Without Slyder®	white		silver	
	4000 K	3000 K	4000 K	3000 K
46W SensoDim®	99W1218L4JS	99W1218L4DS	99H1218L4JS	99H1218L4DS

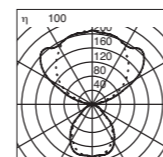

Psys 46W
LL 4000 K 4600lm
LL 3000 K 4200lm
CRI > 80
L70 50'000h
UGR < 16

Free-standing luminaires Tweak CLD, H 1950 mm.

With Slider® technology.

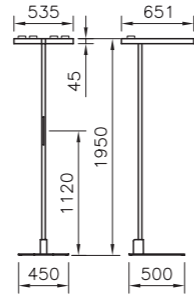

With Slider®	white	silver
4x28W dimmable	99W1102P1.R	99H1102P1.R
4x28W SensoDim®	99W1122P1.S	99H1122P1.S

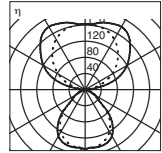

Psys 122 W
4x28W, FSDH, 2GX11
 $\eta > 93\%$
UGR < 16

Without Slider® technology.

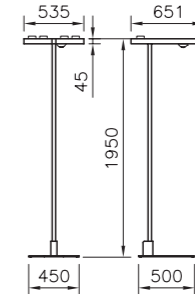

Without Slider®	white	silver
4x28W SensoDim®	99W1124P1.S	99H1124P1.S

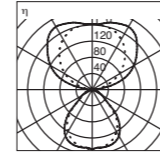

Psys 122 W
4x28W, FSDH, 2GX11
 $\eta > 93\%$
UGR < 16

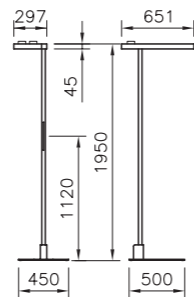

With Slider®	white	silver
2x28W dimmable	99W1202P2.R	99H1202P2.R
2x28W SensoDim®	99W1222P2.S	99H1212P2.S

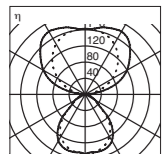

Psys 61 W
2x28W, FSDH, 2GX11
 $\eta > 93\%$
UGR < 16

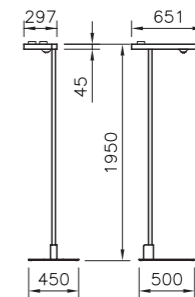

Without Slider®	white	silver
2x28W SensoDim®	99W1224P2.S	99H1214P2.S

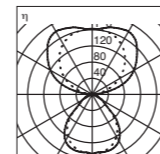

Psys 61 W
2x28W, FSDH, 2GX11
 $\eta > 93\%$
UGR < 16

Free-standing luminaires Tweak CLD, H 2050mm.

With Slider® technology.

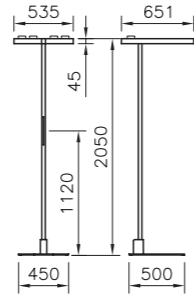

With Slider®		white	silver
4x28W	dimmable	99W1106P1.R	99H1106P1.R
4x28W	SensoDim®	99W1126P1.S	99H1116P1.S

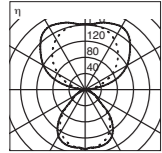

Psys 61W
4x28W, FSDH, 2GX11
 $\eta > 93\%$
UGR < 16

Without Slider® technology.

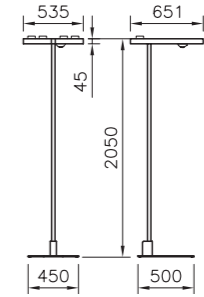

With Slider®		white	silver
4x28W	SensoDim®	99W1128P1.S	99H1118P1.S

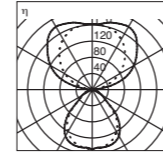

Psys 122W
4x28W, FSDH, 2GX11
 $\eta > 93\%$
UGR < 16

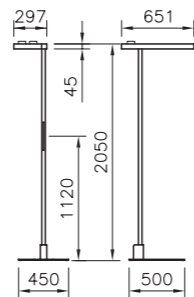

With Slider®		white	silver
2x28W	dimmable	99W1206P2.R	99H1206P2.R
2x28W	SensoDim®	99W1216P2.S	99H1216P2.S

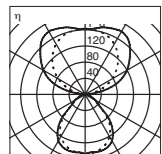

Psys 61W
2x28W, FSDH, 2GX11
 $\eta > 93\%$
UGR < 16

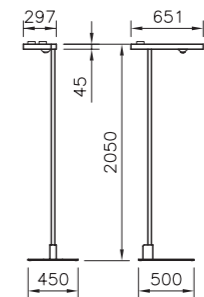

With Slider®		white	silver
2x28W	SensoDim®	99W1218P2.S	99H1218P2.S

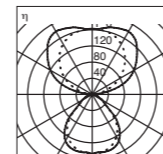

Psys 61W
2x28W, FSDH, 2GX11
 $\eta > 93\%$
UGR < 16

ALONE at WORK®

Communication module for wireless connection of Tweak free-standing luminaires.



For Tweak CLD LED double-head free-standing luminaires

99KOM1.01

For Tweak CLD LED single-head free-standing luminaires

99KOM2.01

Easy to use:

Connect cables according to the manual, click on ALONEatWORK® without tools, and it is ready for use.

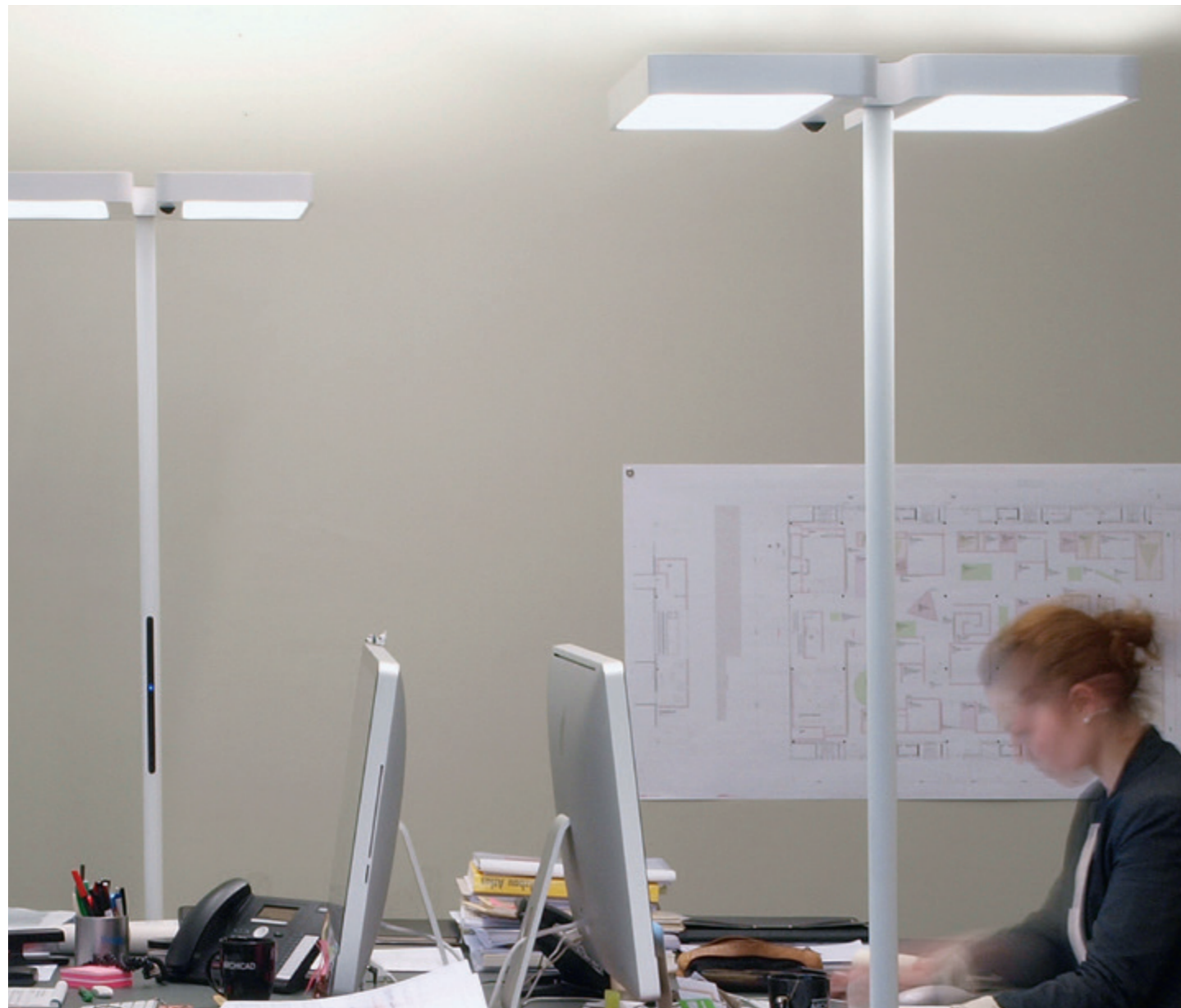

Wall-mounted luminaire Tweak CLD LED.

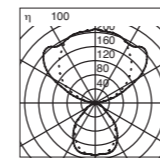
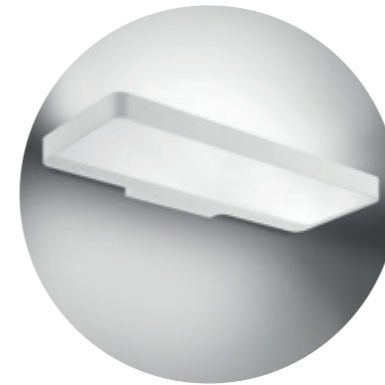

Psys 46 W
LL 4000 K 4600lm
LL 3000 K 4200lm
CRI > 80
L70 50'000h
UGR < 16

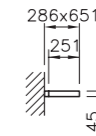

Versions	white		silver	
	4000K	3000K	4000K	3000K
ON/OFF	99W3500L4JA00	99W3500L4DA00	99H3500L4JA00	99H3500L4DA00
dimnable DALI	99W3500L4JC00	99W3500L4DC00	99H3500L4JC00	99H3500L4DC00
SensoDim®	99W3520L4JS00	99W3520L4DS00	99H3520L4JS00	99H3520L4DS00

Wall-mounted luminaire Tweak CLD.

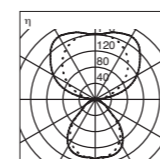
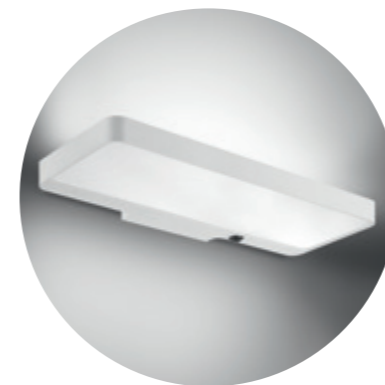

Psys 61 W
2x28W, FSDH, 2GX11
UGR < 16

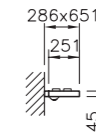

Versions	white	silver
	ON/OFF	99W3500P2.7
dimnable 1...10V	99W3500P2.8	99H3500P2.8
dimnable DALI	99W3500P2.9	99H3500P2.9
SensoDim®	99W3520P2.S	99H3520P2.S

Glossary.

Psys:	System power in Watts (W)
LL:	Luminous flux in lumens (lm)
CCT:	Correlated color temperature in Kelvin (K)
CRI:	Colour Rendering Index
L70:	LED lifespan. Currently typically 50,000hrs, number of operating hours after which the light diode still retains a minimum of 70% of its original luminous flux.
UGR:	Unified Glare Rating, evaluation of the glare standard CIE S 008/E ISO 8995 (CIE117)
ALONEatWORK®	Wireless communication technology enhances communication among luminaires.
Diffusor CLD	(Controlled Luminance Diffusor) Clear microstructured prism surface guaranteeing completely stable light output.
SensoDim®	Daylight and motion detecting light management system.
Slyder®	Operating device Interactive operating device allows the luminaire to be dimmed and switched, with RGB status LED.
Minergie®	Minergie luminaires combine high energy efficiency with good technical characteristics.

Offices

Hauptsitz Schweiz Regent Beleuchtungskörper AG, Dornacherstrasse 390, Postfach 246, CH-4018 Basel, Tel. +41 61 335 51 11, Fax +41 61 335 52 01, info.bs@regent.ch **Bern** Regent Beleuchtungskörper AG, Jupiterstrasse 15, Postfach 170, CH-3000 Bern 15, Tel. +41 31 940 10 10, Fax +41 31 940 10 11, info.be@regent.ch **Genève** Régent Appareils d'éclairage SA, Rue de Saint-Jean 30, CH-1203 Genève, Tél. +41 22 340 34 00, Fax +41 22 340 38 82, info.ge@regent.ch **Lausanne** Régent Appareils d'éclairage SA, Chemin du Rionzi 60, Case postale 432, CH-1052 Le Mont-sur-Lausanne, Tél. +41 21 642 02 02, Fax +41 21 648 21 19, info.ls@regent.ch **Lugano** Regent Illuminazione SA, Via al Mulino 22, CH-6814 Cadempino, Tel. +41 91 966 77 33, Fax +41 91 967 11 01, info.ti@regent.ch **Zürich** Regent Beleuchtungskörper AG, Luggwegstrasse 9, CH-8048 Zürich, Tel. +41 44 497 31 11, Fax +41 44 497 31 61, info.zh@regent.ch **Head Office International** Regent Beleuchtungskörper AG, Dornacherstrasse 390, P.O. Box 246, CH-4018 Basel Switzerland, Tel. +41 61 335 54 82, Fax +41 61 335 55 96, export.bs@regent.ch **Deutschland** Regent Licht GmbH, TechnologiePark, Friedrich-Ebert-Strasse, D-51429 Bergisch Gladbach, Tel. +49 2204 84 37 80, Fax +49 2204 84 37 81, info@regent-licht.de **France** Régent Appareils d'éclairage Sàrl, Siège social 10, place Charles Béraudier, Immeuble l'Orient, F-69428 Lyon Cedex 03, Régent Appareils d'éclairage SA, Siège commercial, Dornacherstrasse 390, Case postale 246, CH-4018 Bâle Suisse, Tél. +41 61 335 54 83, Fax +41 61 335 55 96, info.fr@regent.ch **Israel** Regent Lighting Marketing Ltd., 4, Moshe Sharet St., IL-75704 Rishon Letzion, Phone +972 3 962 29 70, Fax +972 3 962 29 98, service@regentlighting.co.il **Italia** Regent Illuminazione s.r.l., Sede legale, Via Vittor Pisani 16, I-20124 Milano, Tel. +39 02 667 183 78, Fax +39 02 673 861 09, info.it@regent.ch **Österreich** Regent Licht GmbH, Karl-Farkas-Gasse 22, A-1030 Wien, Tel. +43 1 879 12 10, Fax +43 1 879 12 09, info@regent-licht.at **United Kingdom** Regent Lighting UK Ltd., Phone +44 7515 28 65 37, info@regent-lighting.co.uk **India** Regent Lighting Asia Private Limited, A-40, Ground Floor, Sector-80, Phase-II, Noida-201 305, Uttar Pradesh, India, Phone +91 120 473 3028 (North India) Phone +91 120 473 3031 (South & West India) info@regent-lighting.in

www.regent.ch



80.066.EN